



Delivering the **Science** of Nitrogen Generation™

Niagara™  
PSA Nitrogen  
Generators



[holtecllc.com](http://holtecllc.com)

Delivering the **Science** of Nitrogen Generation™

## Reduce Costs, Increase Profits!

Using an in-house nitrogen generator to supply your nitrogen gas demand is the easiest way to reduce nitrogen related costs, and thus increase profits. The Niagara™ Series of Pressure-Swing Adsorption (PSA) nitrogen generators has been designed to be the most efficient, reliable, and durable nitrogen generator available. With a rich list of features and available HoltecConnect™ communications/troubleshooting portal, Niagara™ is the workhorse of the Pressure-Swing Adsorption world.

### Major Features:

- Industry leading purity options, from 95 - 99.9995% (5% residual O<sub>2</sub> - 5 ppm residual O<sub>2</sub>)
- Low power consumption - lowest compressed air consumption reduces compressor horsepower, reducing customer electrical costs
- Modbus TCP/IP standard for connection to customer controls. Many other protocols available upon request.
- EnergyAssistant™ is always included in every Niagara. HoltecConnect™ is an additional cost.
- Holtec Prevue™ technology allows customer to quickly confirm final purity or continuous monitoring of independent systems sharing one nitrogen tank.
- Molecular Sieve - "The active ingredient" lasts 10+ years with proper maintenance
- Adsorbers designed for 20+ years life
- Durable mechanical valves - 2½" and below rated for 5 million cycles (10+ years), 3" and above rated for 3 million cycles (6+ years)

- O<sub>2</sub> analyzer with zirconia sensor - Long sensor life, no calibration needed
- Tamper resistant controls and password protected screens

### Energy Assistant™

#### - Savings tailored to the customer need

A Holtec PSA consumes the least amount of compressed air (and therefore the least amount of electricity). This is because we use only the highest quality, most efficient carbon molecular sieve in our PSAs. The PSA will also detect when you are not using any nitrogen and stop, using no electricity at all.

But what about when you are using something in between? Traditional PSA systems will consume nearly the same amount of compressed air whenever they are running, regardless of the customer's actual demand.

EnergyAssistant™, built into every Niagara™ PSA, adjusts on the fly so the compressed air demand decreases at a nearly 1:1 rate with your nitrogen usage between 40%-100%. Even below 40% of full capacity you will experience significant energy savings. With EnergyAssistant™, customers whose demands vary will now maximize their energy savings in all usage profiles.

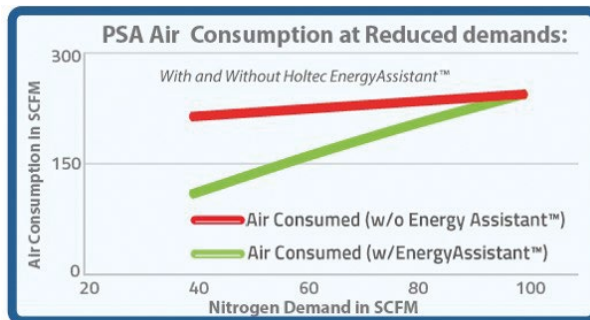

## HoltecConnect™ - Remote gateway for monitoring and factory support

HoltecConnect™, available on any Niagara™ PSA system, allows any user with security clearance to access the nitrogen generator vital statistics through a secure connection from a web browser anywhere an internet connection is available.

Your authorized Holtec dealer can use this powerful tool to continuously monitor the nitrogen generator for you, averting downtimes and freeing up your manpower to concentrate on your primary business.

Easily disabled for added security, HoltecConnect™ is not just for monitoring. With additional sensors throughout the nitrogen generator, this gateway gives factory personnel the ability to diagnose many issues without the delay and expense of a field visit. Many corrections can be made remotely, and when on-site visits are required, technicians are better able to assess which parts to bring in order to reduce follow up visits.

### Other Capabilities include:

- Email alerts and warnings
- Text messages directly to mobile phone or tablet (without the need for a cellular modem)
- Real-time display of nitrogen purity, pressure, and flow
- Nitrogen generator START/STOP functionality
- Change process parameters
- View/Graph system performance (real-time and historical)

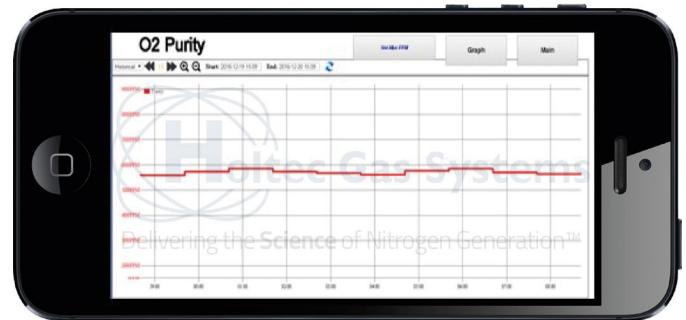
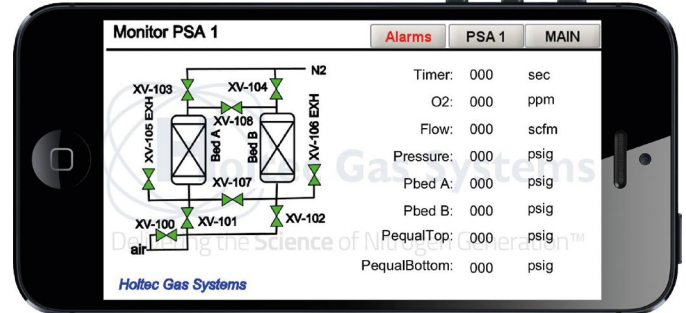
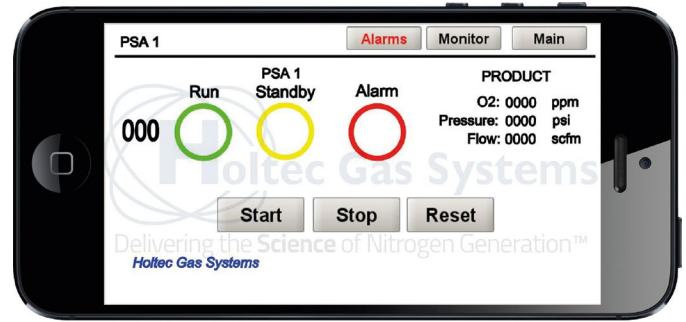



Delivering the **Science** of Nitrogen Generation™

### Niagara™ General Specifications

- 100 - 230V - 1ph - 50/60 Hz- max 120W
- Standard systems for Indoor use only (Outdoor option under sun/rain shelter available with control panel heater).
- Note that a fork lift is typically required at the destination unless otherwise noted. If a crane is needed at the origin or destination for larger systems, this is at the buyer's expense. Systems are shipped horizontally and partially disassembled; fork lift or crane required to re-orient and re-assemble.
- Clean, dry, oil-free compressed air (ISO 8573 Class 1.4.1 or better with an activated carbon adsorber tower must be used if the compressor is not of the oil-free variety). See below for a typical arrangement when lubricated screw compressors are used.

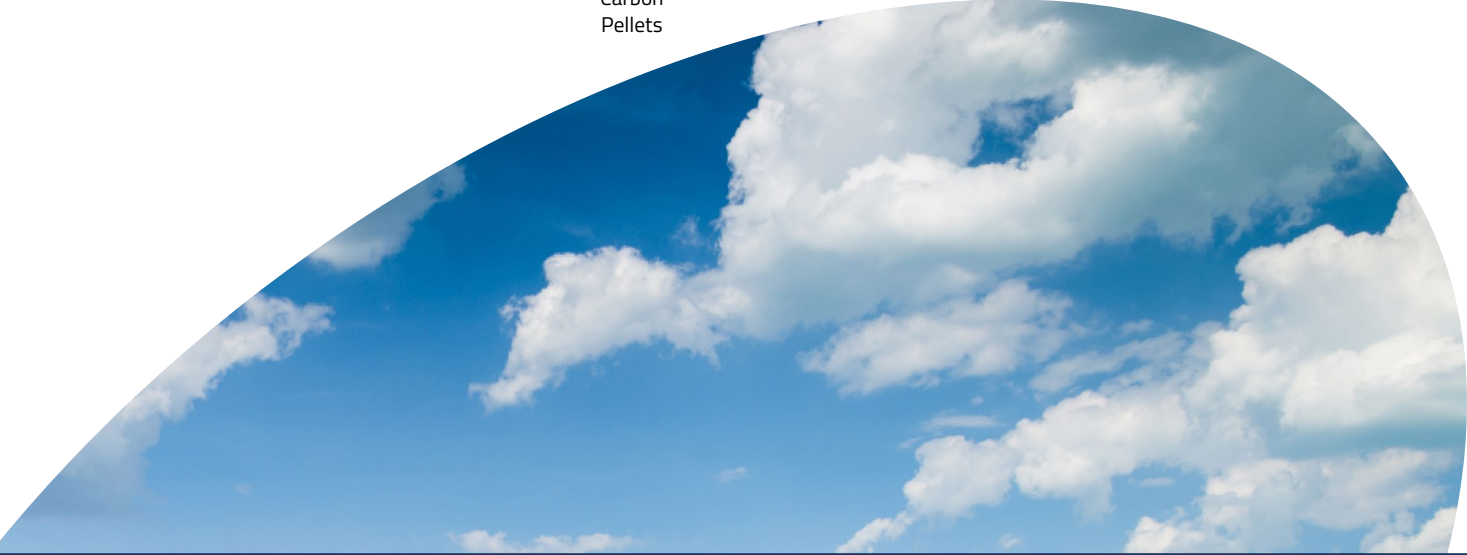
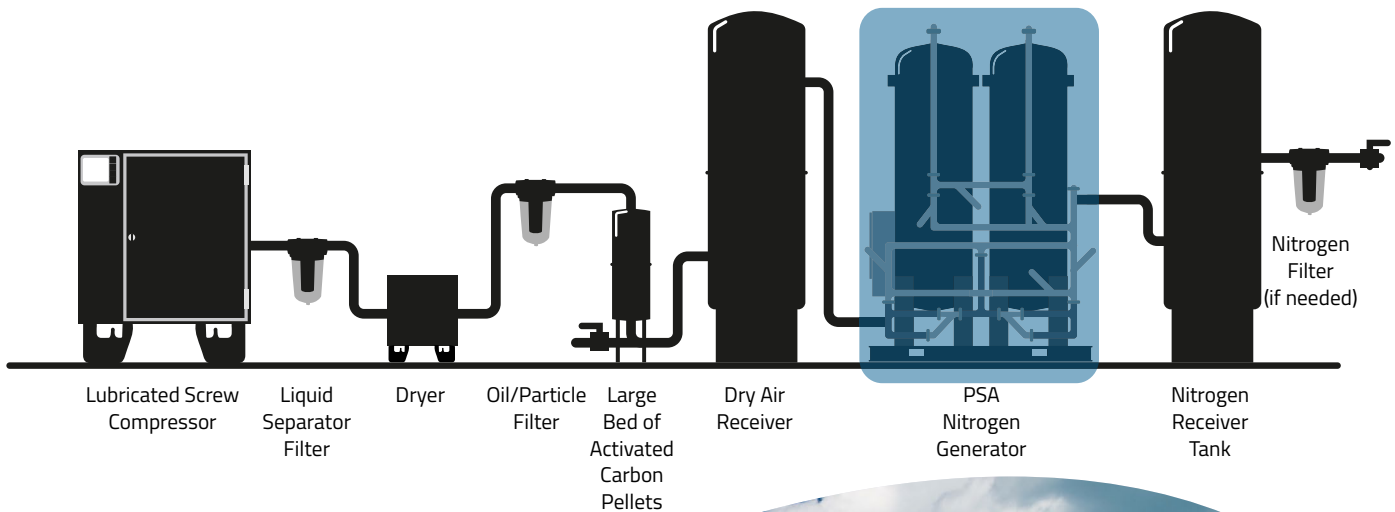

## Niagara™ Physical Characteristics (Dimensions in inches, weight in pounds)

Model Number	Max Inlet Pressure (psig)	Inlet (in.)	Outlet (In.)	Length (In.)	Width (In.)	Height (In.)	Weight (lb.)
HNS-245M	150	1.5	1.5	76	48	124	3,450
HNS-265M	150	1.5	1.5	76	48	132	3,610
HNS-300M	150	1.5	1.5	76	48	142	3,810
HNS-320M	150	2	1.5	76	48	108	4,870
HNS-355M	150	2	1.5	76	48	115	5,090
HNS-400M	150	2	1.5	76	48	124	5,380
HNS-435M	150	2	1.5	76	48	133	5,710
HNS-480M	150	2	1.5	76	48	144	5,930
HNS-530M	135	2	2	76	48	119	6,120
HNS-585M	135	2	2	76	48	128	6,430
HNS-645M	135	2	2	76	48	137	6,760
HNS-715M	135	2	2	76	48	147	7,120
HNS-780M	135	2	2	76	48	157	7,480
HNS-850M	135	3	2	95	53	125	8,030
HNS-940M	135	3	2	95	53	135	8,510
HNS-1025M	135	3	2	95	53	143	8,990
HNS-1130M	135	3	2	95	53	153	9,550
HNS-1245M	135	3	2	95	53	164	10,170
HNS-1370M	135	3	2	95	53	177	10,870
HNS-1515M	150	4	3	111	60	148	14,090
HNS-1675M	150	4	3	111	60	159	15,010
HNS-1840M	150	4	3	111	60	171	15,980
HNS-2005M	150	4	3	111	60	182	16,910
HNS-2205M	130	4	3	120	66	158	17,430
HNS-2440M	130	4	3	120	66	170	19,200
HNS-2690M	130	4	3	120	66	183	20,540
HNS-2970M	130	4	3	120	66	197	22,030
HNS-3300M	135	4	4	120	66	213	23,760
HNS-3610M	135	6	4	135	76	190	28,620
HNS-3980M	135	6	4	135	76	204	30,650
HNS-4400M	135	6	4	135	76	220	32,950

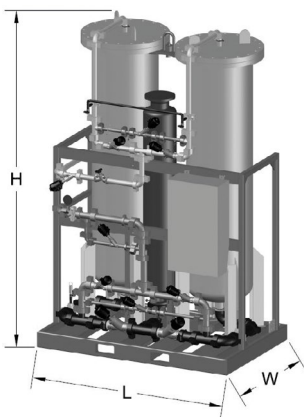

**Notes:**

\* N2 pressure will typically be 25 psi lower than compressor outlet pressure (with reasonable pressure drop for filters included). In some cases, lower pressure drop may be possible. Please consult factory for details where critical.

## Scope of Supply

- ASME VIII Div 1 adsorber vessels filled with Carbon Molecular Sieve
- Relief valves
- Air actuated switching valves
- Pressure gauges
- Control panel with:
  - Terminal blocks supplied for hard-wired power connection (cannot be plugged into wall outlet included unless otherwise stated)
  - On/Off power switch
  - PLC control with touch-screen interface (HMI)
  - Switching for continuous or standby operation (HMI feature)
  - Operating hours recorder (displayed on HMI)
  - Electrical terminal blocks and wiring
  - Solenoid valves (for switching valves)
  - N2 pressure sensing transducer for automatic standby operation
  - Oxygen analyzer sampling system and oxygen analyzer and sensor
- Manual control valves for setting N2 flow and purity
- Manual isolation valves
- Silencer for waste gas
- Digital Operating and maintenance Manual (digital only, unless otherwise agreed)
- Fittings, Piping, and tubing
- N2 flow limiting device
- All above equipment to be pre-assembled and pre-tested mounted on a painted steel skid for easy site installation and quick startup





Delivering the **Science** of Nitrogen Generation™

### Niagara™ Performance\* - 70 °F (Flows listed in SCFM)

Model Number	95%	96%	97%	98%	99%	99.5%	99.9%	99.95%	99.99%	99.995%	99.999%
HNS-245M	119.5	108.7	100.2	84.3	67.9	60.0	45.2	40.0	30.1	26.1	19.6
HNS-265M	130.1	118.3	109.1	91.8	73.9	65.3	49.2	43.5	32.7	28.4	21.4
HNS-300M	143.3	130.4	120.2	101.1	81.5	71.9	54.2	47.9	36.1	31.3	23.5
HNS-320M	149.5	136.0	125.5	105.5	85.0	75.1	56.5	50.0	37.6	32.7	24.6
HNS-355M	163.8	149.0	137.4	115.6	93.1	82.2	61.9	54.8	41.2	35.8	26.9
HNS-400M	182.2	165.8	152.9	128.6	103.6	91.5	68.9	60.9	45.9	39.8	29.9
HNS-435M	200.6	182.5	168.3	141.6	114.0	100.7	75.8	67.1	50.5	43.8	32.9
HNS-480M	223.1	202.9	187.1	157.4	126.8	112.0	84.3	74.6	56.1	48.7	36.6
HNS-530M	245.0	222.8	205.5	172.9	139.3	123.0	92.6	81.9	61.6	53.5	40.2
HNS-585M	271.8	247.2	228.0	191.8	154.5	136.4	102.7	90.9	68.4	59.4	44.6
HNS-645M	298.6	271.6	250.5	210.7	169.8	149.9	112.9	99.9	75.1	65.3	49.0
HNS-715M	328.4	298.7	275.5	231.8	186.7	164.9	124.1	109.8	82.6	71.8	53.9
HNS-780M	358.2	325.8	300.5	252.8	203.6	179.8	135.4	119.8	90.1	78.3	58.8
HNS-850M	392.3	356.8	329.1	276.9	223.0	196.9	148.3	131.2	98.7	85.7	64.4
HNS-940M	434.7	395.4	364.7	306.8	247.1	218.2	164.3	145.4	109.4	95.0	71.4
HNS-1025M	477.2	434.1	400.3	336.8	271.3	239.5	180.4	159.6	120.1	104.3	78.4
HNS-1130M	524.3	477.0	439.8	370.1	298.1	263.2	198.2	175.4	131.9	114.6	86.1
HNS-1245M	576.2	524.1	483.4	406.7	327.6	289.2	217.8	192.7	145.0	125.9	94.6
HNS-1370M	637.5	579.9	534.8	449.9	362.4	320.0	241.0	213.2	160.4	139.3	104.7
HNS-1515M	697.0	634.0	584.7	491.9	396.2	349.9	263.5	233.1	175.4	152.3	114.5
HNS-1675M	771.3	701.6	647.0	544.3	438.5	387.2	291.6	257.9	194.1	168.5	126.7
HNS-1840M	852.3	775.3	715.0	601.5	484.5	427.8	322.2	285.0	214.4	186.3	140.0
HNS-2005M	926.6	842.8	777.3	654.0	526.7	465.1	350.3	309.9	233.1	202.5	152.2
HNS-2205M	1017.9	926.0	853.9	718.4	578.7	511.0	384.8	340.4	256.1	222.4	167.2
HNS-2440M	1129.1	1027.1	947.2	796.9	641.9	566.8	426.8	377.6	284.1	246.7	185.4
HNS-2690M	1249.6	1136.7	1048.2	881.9	710.4	627.3	472.4	417.9	314.4	273.1	205.2
HNS-2970M	1379.3	1254.7	1157.1	973.5	784.1	692.4	521.4	461.3	347.0	301.4	226.5
HNS-3300M	1528.5	1390.4	1282.2	1078.8	868.9	767.3	577.8	511.2	384.6	334.0	251.0
HNS-3610M	1673.1	1521.9	1403.5	1180.8	951.1	839.9	632.5	559.5	421.0	365.6	274.7
HNS-3980M	1841.7	1675.3	1545.0	1299.9	1047.0	924.5	696.2	615.9	463.4	402.5	302.4
HNS-4400M	2034.5	1850.7	1706.7	1435.9	1156.6	1021.3	769.1	680.4	511.9	444.6	334.1
Air Factor	1.817	1.887	1.976	2.100	2.312	2.522	3.002	3.234	3.849	4.107	4.693

\* Performance and air factor listed is for ambient temperature 70° F and inlet pressure 110 psig.  
Please consult Holtec for performance at other conditions. Air factor listed may vary by ±5%.



Your Nitrogen generator plays a critical role in your facility. Because quality is so essential, we now offer NitroCheck™ tests to help provide you with peace of mind that your equipment continues to operate at its best. Contact us for more information.

### Niagara™ Performance - 95 °F\* (Flows listed in SCFM)

Model Number	95%	96%	97%	98%	99%	99.5%	99.9%	99.95%	99.99%	99.995%	99.999%
HNS-245M	112.5	104.0	93.0	79.8	64.1	55.7	41.2	36.2	26.8	23.5	17.4
HNS-265M	122.4	113.2	101.2	86.8	69.8	60.6	44.9	39.4	29.2	25.6	19.0
HNS-300M	134.9	124.7	111.5	95.7	76.9	66.8	49.4	43.4	32.1	28.2	20.9
HNS-320M	140.8	130.2	116.4	99.8	80.3	69.7	51.6	45.3	33.5	29.5	21.8
HNS-355M	154.2	142.6	127.5	109.4	88.0	76.3	56.5	49.6	36.8	32.3	23.9
HNS-400M	171.6	158.6	141.8	121.7	97.8	84.9	62.9	55.2	40.9	35.9	26.6
HNS-435M	188.9	174.6	156.1	133.9	107.7	93.5	69.2	60.8	45.0	39.5	29.3
HNS-480M	210.0	194.2	173.6	148.9	119.8	103.9	76.9	67.6	50.0	44.0	32.6
HNS-530M	230.6	213.2	190.6	163.6	131.5	114.1	84.5	74.2	55.0	48.3	35.7
HNS-585M	255.9	236.6	211.5	181.5	145.9	126.6	93.7	82.4	61.0	53.6	39.7
HNS-645M	281.1	259.9	232.4	199.4	160.3	139.1	103.0	90.5	67.0	58.9	43.6
HNS-715M	309.2	285.9	255.6	219.3	176.3	153.0	113.3	99.5	73.7	64.7	47.9
HNS-780M	337.2	311.8	278.8	239.2	192.3	166.9	123.5	108.5	80.4	70.6	52.3
HNS-850M	369.3	341.5	305.3	261.9	210.6	182.8	135.3	118.9	88.0	77.3	57.2
HNS-940M	409.2	378.4	338.3	290.3	233.4	202.5	149.9	131.7	97.5	85.7	63.4
HNS-1025M	449.2	415.3	371.3	318.6	256.2	222.3	164.6	144.6	107.0	94.0	69.6
HNS-1130M	493.6	456.4	408.0	350.1	281.5	244.3	180.8	158.9	117.6	103.3	76.5
HNS-1245M	542.4	501.5	448.4	384.7	309.3	268.5	198.7	174.6	129.3	113.6	84.1
HNS-1370M	600.2	554.9	496.1	425.7	342.2	297.0	219.9	193.2	143.0	125.7	93.0
HNS-1515M	656.1	606.7	542.4	465.4	374.2	324.7	240.4	211.2	156.4	137.4	101.7
HNS-1675M	726.1	671.3	600.2	515.0	414.0	359.3	266.0	233.7	173.0	152.0	112.5
HNS-1840M	802.3	741.9	663.3	569.1	457.5	397.1	294.0	258.3	191.2	168.0	124.4
HNS-2005M	872.3	806.5	721.1	618.7	497.4	431.7	319.6	280.8	207.9	182.6	135.2
HNS-2205M	958.3	886.0	792.2	679.7	546.5	474.3	351.1	308.5	228.4	200.6	148.5
HNS-2440M	1063.0	982.8	878.7	753.9	606.2	526.1	389.4	342.1	253.3	222.5	164.8
HNS-2690M	1176.4	1087.7	972.5	834.3	670.8	582.2	431.0	378.7	280.3	246.3	182.3
HNS-2970M	1298.5	1200.6	1073.4	920.9	740.5	642.6	475.7	418.0	309.4	271.9	201.3
HNS-3300M	1438.9	1330.5	1189.5	1020.6	820.6	712.2	527.2	463.2	342.9	301.3	223.0
HNS-3610M	1575.0	1456.3	1302.0	1117.1	898.2	779.5	577.0	507.0	375.3	329.8	244.1
HNS-3980M	1733.8	1603.1	1433.3	1229.7	988.7	858.1	635.2	558.1	413.2	363.0	268.7
HNS-4400M	1915.3	1770.9	1583.3	1358.4	1092.2	947.9	701.7	616.5	456.4	401.0	296.9
Air Factor	1.924	2.002	2.103	2.245	2.485	2.722	3.266	3.568	4.340	4.665	5.401

\* Performance and air factor listed is for ambient temperature 95° F and inlet pressure 110 psig. Please consult Holtec for performance at other conditions. Air factor listed may vary by ±5%.





# Niagara™ PSA Nitrogen Generators

**At Holtec, your satisfaction is our top priority.**

We specialize in providing cutting-edge on-site nitrogen (N<sub>2</sub>) generator systems catering to various industries. With our focus on innovation, efficiency, reliability, and performance, we are your ultimate provider for all nitrogen generation needs.

We are experts at designing a solution that is right for your needs rather than simply providing a standard product. We will work with you to solve your application challenges. Let Holtec be your valued partner during the N<sub>2</sub> generation system selection process!



Delivering the **Science** of Nitrogen Generation™



3770B, Units 2-4, Mississauga, ON. L5L 0A7  
Toll Free: 1-800-951-0777, Fax: 905-820-3490  
sales@cagtech.com, www.cagtech.com

